

LES BARREAUX **SNAP 'N LOCK**®

Niveau

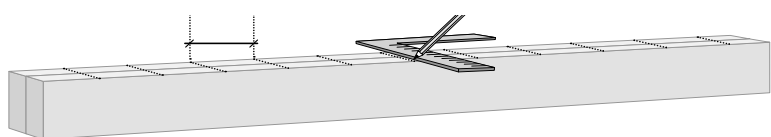

À partir du centre des rails, tracez une ligne à tous les 4,5 po ou tel qu'exigé par les codes locaux.

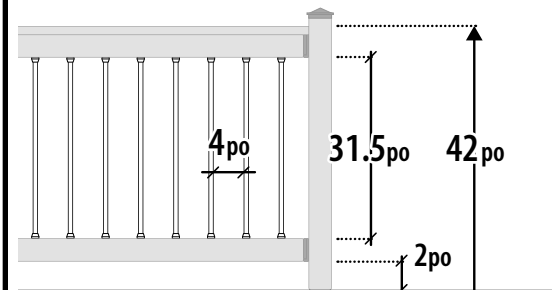
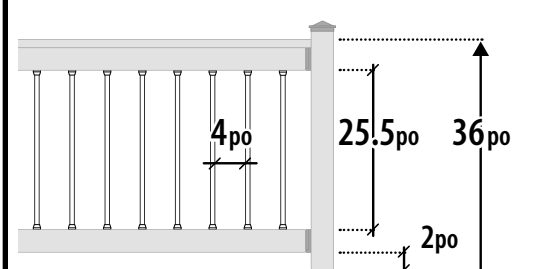

Espace maximal de 4 po entre chaque barreau.

1
Visser

2
Cliquer

3
Barrer

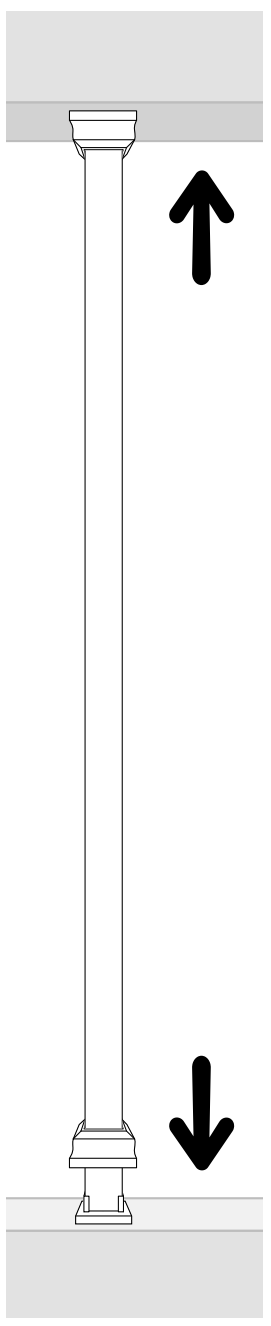
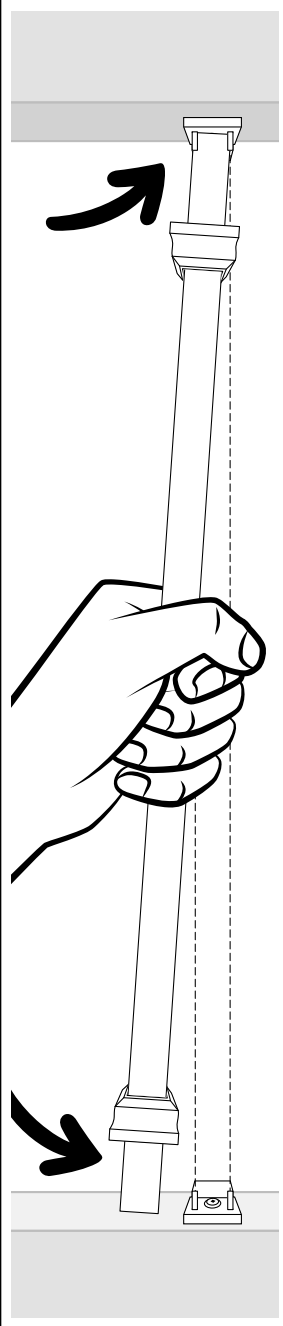

! IMPORTANT !

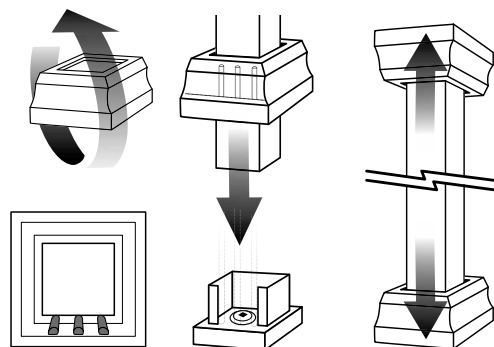

Les colliers ont des COLONNES D'ALIGNEMENT mâle interne

Aligner LES COLONNES avec l'ouverture Femelle

FAITES GLISSER et PUSSEZ pour VERROUILLER les colliers avec les bases

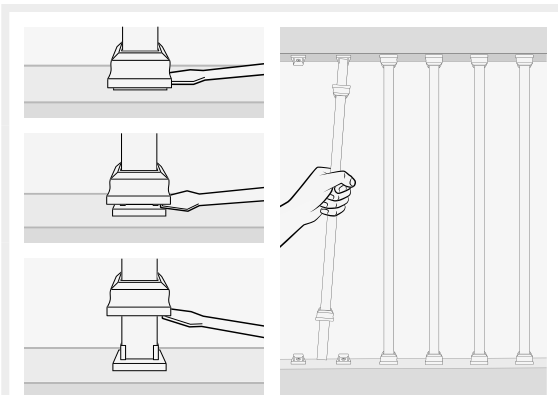

La **recoloration** ou la **modernisation** des anciens rails est **rapide** et **facile**.

DES QUESTIONS? 1-866-577-8868 EN AUCUN CAS, TITAN BUILDING PRODUCTS NE PEUT ÊTRE TENU RESPONSABLE DE LA PERTE OU DES DOMMAGES, DIRECTS OU NON, QUI RÉSULTENT D'UNE UTILISATION OU D'UNE INSTALLATION INADÉQUATE DE CE PRODUIT. SI, POUR QUELQUE RAISON QUE CE SOIT, TITAN BUILDING PRODUCTS DEVIENT RESPONSABLE DE LA PERTE OU DES DOMMAGES, DIRECTS OU NON, LA RESPONSABILITÉ GLOBALE DE TITAN BUILDING PRODUCTS SERA LIMITÉE AU PRIX D'ACHAT AU DÉTAIL DU PRODUIT.

BREVET N°

US 11,274,451

GB 2563328

CA 3,001,589



www.titanbp.com/warranty

GARANTIE

Titan Building Products offre une garantie limitée du fabricant. Des conditions générales s'appliquent.

TITAN BUILDING PRODUCTS®
THE ART OF BUILDING

More Outdoor Beauty... Real easy.



1-866-577-8868

www.titanbp.com

CARRÉ

LES BARREAUX **SNAP'N LOCK**®

Adaptateur d'escalier

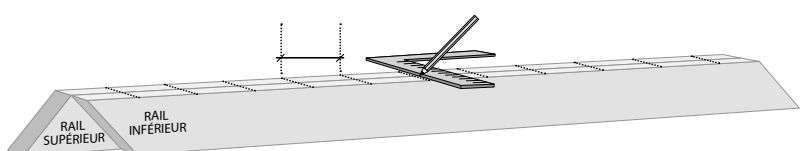

Inversez les travées tel qu'illustré.
En partant du centre, tracez des lignes à tous les 5,5 po.

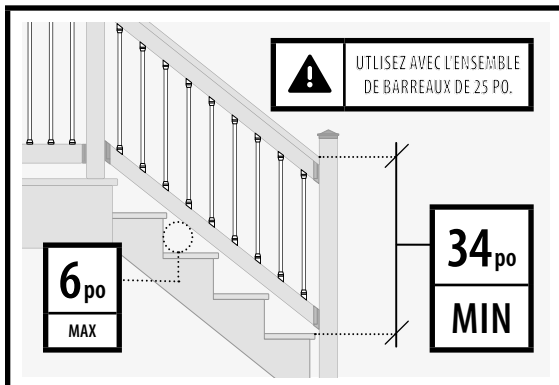

1 Screw

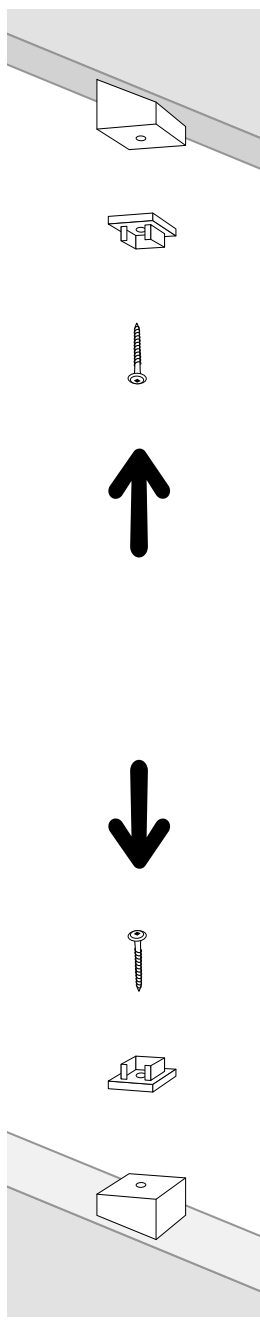

2 Snap

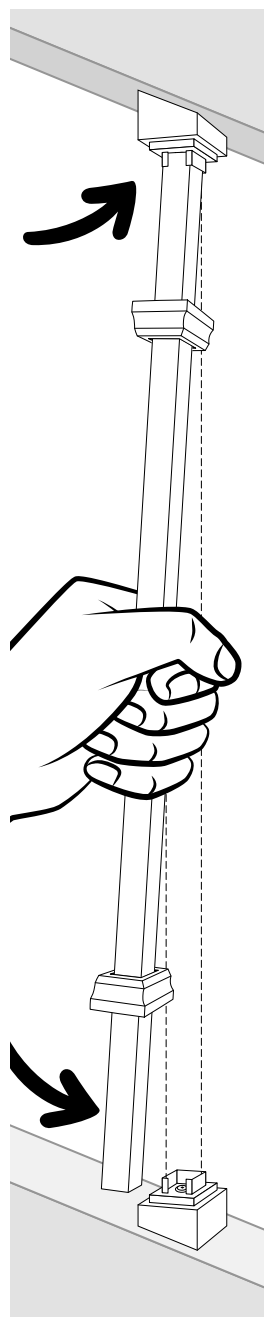

3 Lock

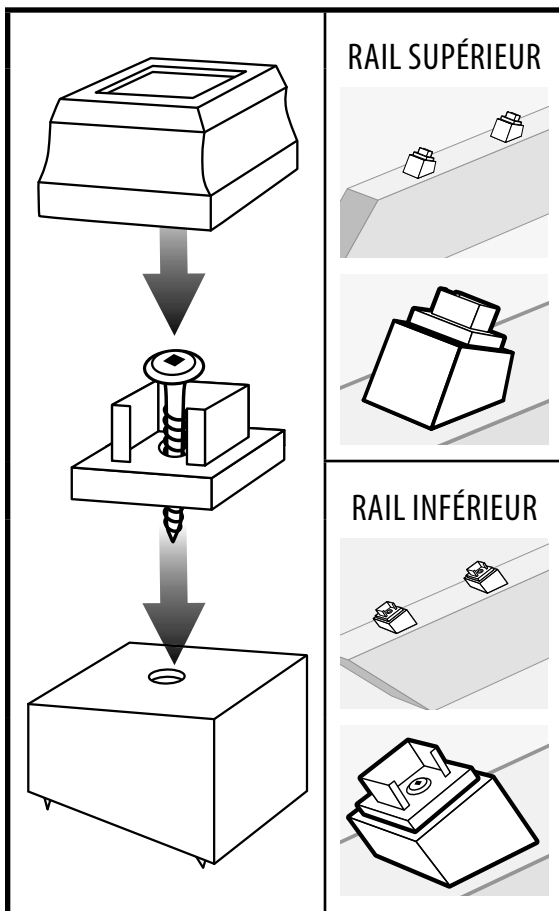
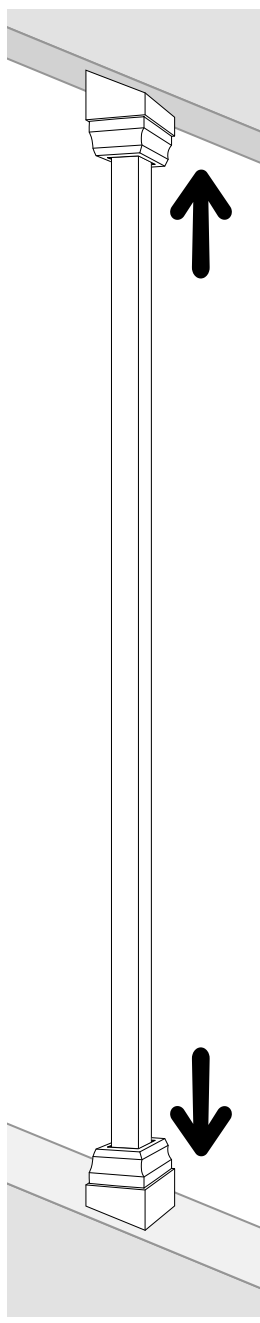

! IMPORTANT !

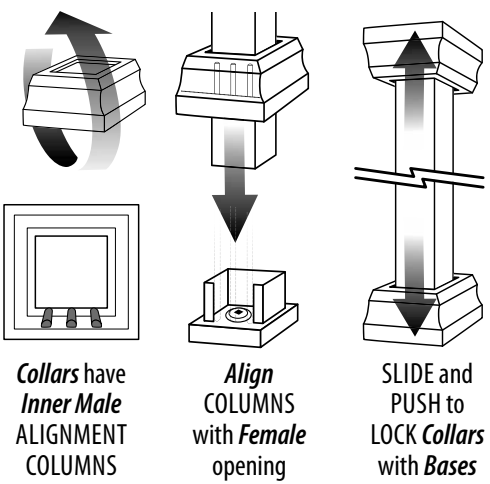

QUESTIONS? 1-866-577-8868 IN NO EVENT SHALL TITAN BUILDING PRODUCTS BE LIABLE FOR ANY LOSS OR DAMAGE, DIRECT OR OTHERWISE, WHICH RESULTS FROM THE IMPROPER INSTALLATION OR USE OF THIS PRODUCT. IF FOR ANY REASON TITAN BUILDING PRODUCTS BECOMES LIABLE FOR LOSS OR DAMAGE, DIRECT OR OTHERWISE, THE AGGREGATE LIABILITY OF TITAN BUILDING PRODUCTS SHALL BE LIMITED TO THE RETAIL PURCHASE PRICE OF THE PRODUCTS.

PATENT N°

US 11,274,451

GB 2563328

CA 3,001,589



www.titanbp.com/warranty
WARRANTY
Titan Building Products offers a Limited Manufacturer's Warranty. Terms and Conditions Apply.

TITAN BUILDING PRODUCTS
THE ART OF BUILDING
More Outdoor Beauty... Real easy.



1-866-577-8868

www.titanbp.com