

INSTALLATION | WOOD POST ANCHOR 6x6 | Softwood

IMPORTANT

! Do not use on surfaces 30" or higher (U.S.A.) or 600mm / 23.62" (CAN) or higher *UNLESS* you build according to our Engineering Reports (See QR link below) *AND* obtain approval by your local authority. **!** Use only Stainless Steel Screws with Aluminum Decking. Sold Separately.

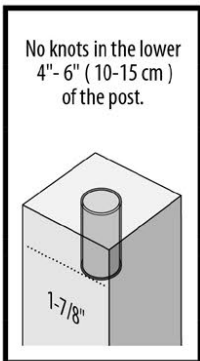
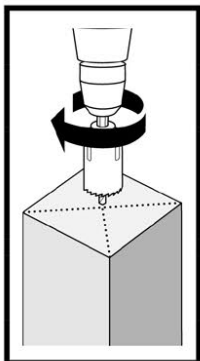
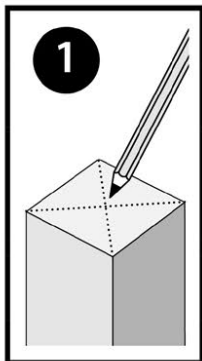

TITAN WOOD POST ANCHOR™ KIT

(8) *Wood Screw #14X4" T27 Drive

(6) Lag Screw 1/2" X 5"*

**Concrete screws sold separately.*

ACQ

RECOMMENDED TOOLS

Hardwood Installations Only

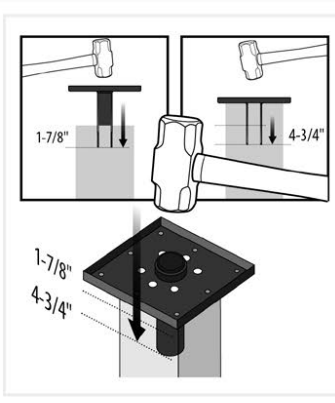
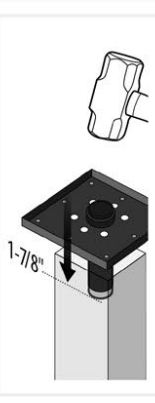
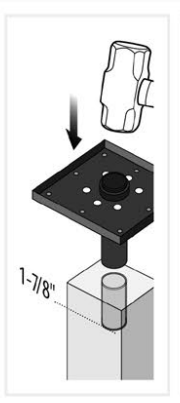
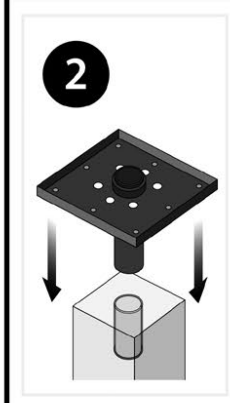

POST BRACE

RECOMMENDED ACCESSORY
WHEREVER EXTRA STRENGTH IS DESIRED

POST BRACE DETAIL

3 DRILL

PRE-DRILL LAG SCREW TIP

4" DEEP MIN.

3/8" BIT 1/2" LAG

USE A 3/8" BIT AND PRE-DRILL AT LEAST 4" DEEP BEFORE INSTALLING 1/2" LAG SCREWS.

LAG SCREW | DRILL BIT GUIDE

SOFTWOOD POST	
3/8" LAG SCREW	5/16" DRILL BIT
1/2" LAG SCREW	7/16" DRILL BIT
HARDWOOD POST	
3/8" LAG SCREW	11/32" DRILL BIT
1/2" LAG SCREW	15/32" DRILL BIT

RECOMMENDED* ENGINEERED OPTION

(6) 1/2" X 5" LAG SCREWS

**Intertek 103643197TOR-005*

4 BLOCKING (12) #10 X 3-1/2" **SPF**

5/4 Decking 2 x 12 2 x 8

! FOR VERY DRY WOOD, WET ENDS OF POST WITH WATER BEFORE USE TO PREVENT CRACKING.

ENGINEERING REPORTS FOR APPLICATION SUITABILITY

******* ATTENTION *******

Do not use on surfaces 30" (USA) / 600mm (CAN) or higher *UNLESS* you build an assembly exactly as depicted in our engineering reports/illustrations and obtain approval by local building officials. Do not use with cable or vinyl rail systems or as a free standing post.

Engineering reports are for guidance only and complying with them *does not necessarily* mean your structure will be code compliant. Any variation from the assemblies tested in our engineering reports is outside of the scope of the report.

This product is not for industrial, commercial or apartment building applications. It is for private residential use only.

WOOD POST ANCHOR / TIPR6612

www.titanbp.com/warranty

WARRANTY

Titan Building Products offers a Limited Manufacturer's Warranty. Terms and Conditions Apply.

TITAN BUILDING PRODUCTS™

THE ART OF BUILDING

More Outdoor Beauty... Real easy.

1-866-577-8868

www.titanbp.com

INSTALLATION | WOOD POST ANCHOR 6x6 | Hardwood

IMPORTANT

! Use only Stainless Steel Screws with Aluminum Decking. Sold Separately.

1

1-7/8"

1-3/4" dia. Hole Saw

2-3/4"

1-3/4" Forstner Bit

2

4-5/8"

1-3/4" dia. Hole Saw

3

INSTALLATION | WOOD POST ANCHOR 6x6 | Concrete

1

DRILL (1) CORNER HOLE & INSTALL (1) SCREW IN ANCHOR. DRILL (3) CORNER HOLES.
*Concrete screws sold separately. 1/4" x 2-1/4" min. screw size.

2

REMOVE ANCHOR. INSTALL REMAINING SCREWS. (With Wood Post)

***** ATTENTION *****

This product is not for industrial, commercial or apartment building applications. It is for private residential use only. If you wish to use this product for any residential code application including a railing, engage local professionals before beginning work: (i) to ensure that this product is appropriate for your intended use and that the structural components which this product is to be used in conjunction with are sound and that the work area is safe and free from all potential hazards including utilities and other services, (ii) to provide clarification if these warnings are unclear or you do not understand any of the information in the installation instructions for this product. Always comply with applicable building codes. Be aware that building codes may vary.

When using tools always comply with the applicable user manuals and instructions. Everyone in the vicinity of any work area must wear appropriate protective gear including gloves, footwear, eyewear, hardhat and appropriate clothing. Inspect and maintain these products and the structural components that they are used in connection with on a regular basis using professionals when appropriate. Always work in a safe manner.

In no event shall Titan Building Products be liable for any loss or damage, direct or otherwise, which results from the improper use of this product. If for any reason Titan Building Products becomes liable for loss or damage, direct or otherwise the aggregate liability of Titan Building Products shall be limited to the retail purchase price of the products.

WOOD POST ANCHOR / TIPR6612



www.titanbp.com/warranty

WARRANTY

Titan Building Products offers a Limited Manufacturer's Warranty. Terms and Conditions Apply.



1-866-577-8868

www.titanbp.com